

SHELTER PRO

SP1220 / SP1240 Assembly Manual

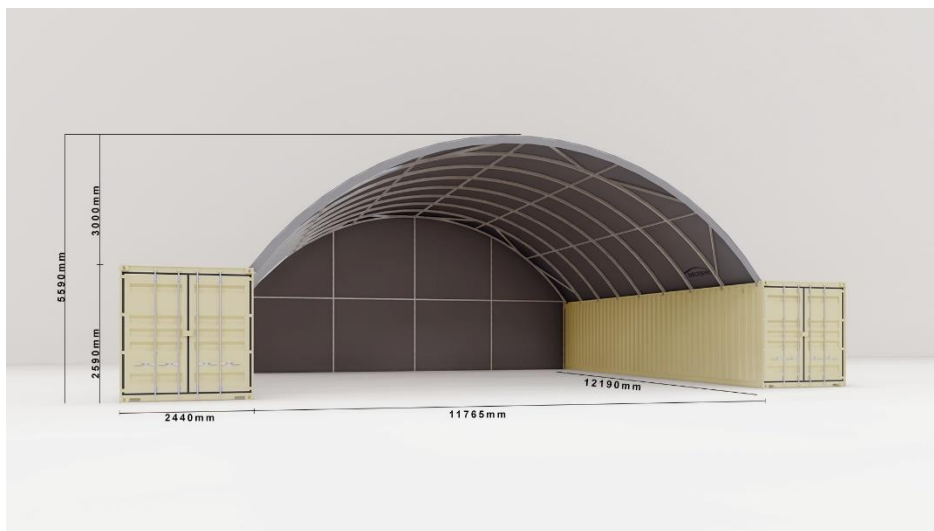

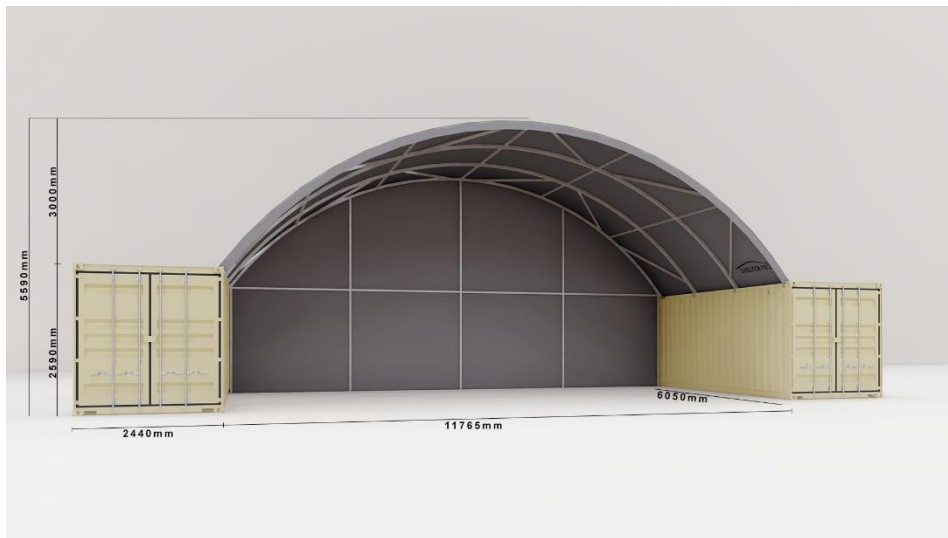

SHELTER PRO

Congratulations on the purchase of this ShelterPro product.

To be sure to get the most out of your purchase, please take your time to install it properly and consider the following:

We offer a manufacturer's warranty that ensures this product is complete at the time of your purchase. Please check all the components upon delivery and advise immediately if any parts are missing or faulty.

We offer no guarantee or warranty for the product, its life or its ability to withstand weather or wind. For your protection, exercise caution during adverse weather conditions, both during the assembly process and use.

We will not assume any responsibility for any loss or any claims by any parties that may arise through the use of these shelters.

IMPORTANT – Please read this manual first.

Improper site preparation, assembly, or care & maintenance may cause unnecessary, time-consuming, or costly mistakes.

If you have any questions please contact ShelterPro.

info@shelterpro.co.nz / www.shelterpro.co.nz

PLEASE READ ALL THE INSTRUCTIONS BEFORE ASSEMBLY

1. The proper erection and installation of this shelter requires a high level of care and safety. We recommend the safety regulations be complied with during the installation. It includes but is not limited to:
 - Safety hats, protective clothing
 - Safety harnesses for all elevated workers
 - Proper ladder, cage, and safety operation
2. Be cautious with the surroundings. The cover of the shelter will protect against normal falling leaves and light debris, however, large, fast, or sharp falling items may cause a puncture or tear in the cover material.
3. Choose a windless day to install the shelter. It is difficult to attach the cover in heavy wind.
4. To elongate the life of the cover, please utilize the provided frame tape or use duct tape on the frame that comes in contact with the cover. The tape acts as a cushion to avoid rubbing damage to the cover over the years of use.

If you have any questions please contact ShelterPro.

info@shelterpro.co.nz / www.shelterpro.co.nz

ASSEMBLY PROCEDURE

1. Prepare location and place all unit boxes near location sight. Perform an inventory check before beginning, to be certain all components are available for installation.
2. Weld base plates to the top of the containers as per the provided base plate layout diagram.
3. Assemble all arches on the ground.
4. Begin frame assembly by lifting all arches into position and attaching the previously installed base plates.
5. Add and secure all purlins to the erected arches followed by V bracing on applicable models.
6. Install the main cover over the frame.
7. Tension accordingly.

Read all the detailed instructions and notices in the following assembly instructions

MAINTENANCE AND CARE

- ✓ Ensure the cover remains tight, periodically check ratchets and lacing ropes, and tighten as necessary. If the cover becomes loose, fix the problem immediately to avoid water pooling or the wind pulling and straining the structure. Keep checking this occasionally the entire time your shelter is assembled.
- ✓ All snow or debris accumulation on the main cover should be removed as soon as possible.
- ✓ In the event of severe weather or cyclonic weather conditions being forecast, we recommend removing the cover from your shelter to avoid damage being caused by other flying debris or severe wind.
- ✓ The shelter should be completely inspected and maintained regularly both internally and externally to make certain the shelter remains properly installed and secured.
 - Check all bolts and hardware remain in place and tightened.
 - The base plates are still fixed firmly.
 - Check and adjust the ropes and ratchets – tighten as required.
 - Keep the cover clean with regular washing as required. Allowing dirt and debris to sit on the cover over an extended time can damage the cover irreparably and void the warranty.

ShelterPro SP1220 / SP1240 Container Shelter

PARTS LIST

PART #	DESCRIPTION	QUANTITY 20'	QUANTITY 40'
L1	Base plates	4	8
L2	Base plates	4	8
1	Top portals	4	8
2	Upper portals	8	16
2A	Mid portals	8	16
3	Side portals	8	16
4	Connection purlins	15	35
5	Bracing	12	12
6	Bracing brackets	24	24
7	Tensioning tubes	4+2	12+2
8	Ratchet for four corners	4	4
9	Roof cover	1	1
10	End plugs tensioning tubes	4	4
11	Lacing ropes for cover	8	8
12	Hexagon bolts for swaged ends	70	142
13	Carriage bolts for purlins	26	45
14	Ratchet straps	8	16
15	Ratchet and bolt (installed)	8	16
16	Frame tape & cable ties	24+24	48+48
17	Bolts for bracing brackets	30	30

ASSEMBLED FRAME

12x 20ft ShelterPro Container Shelter

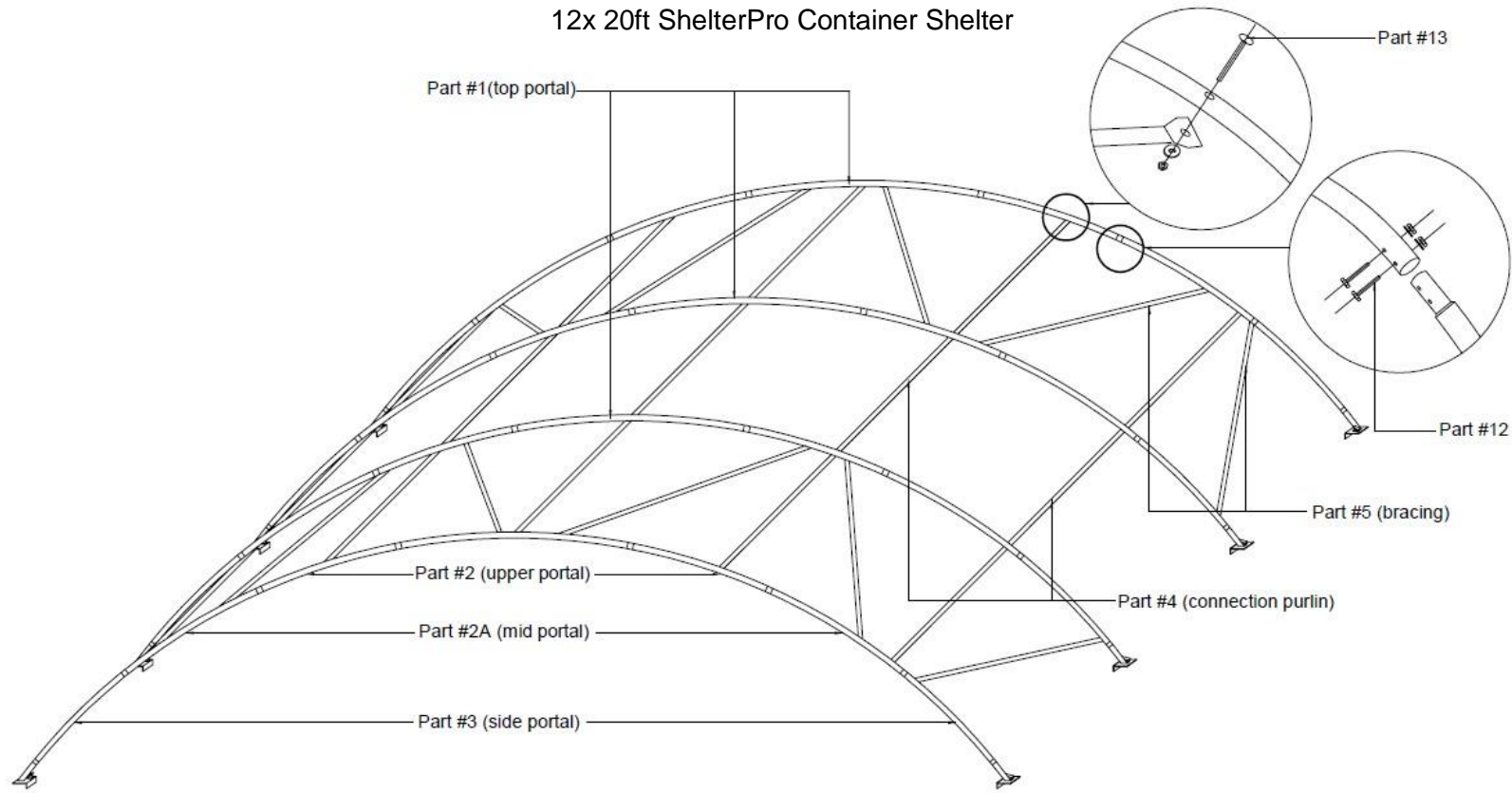

ASSEMBLED FRAME

12x 40ft ShelterPro Container Shelter

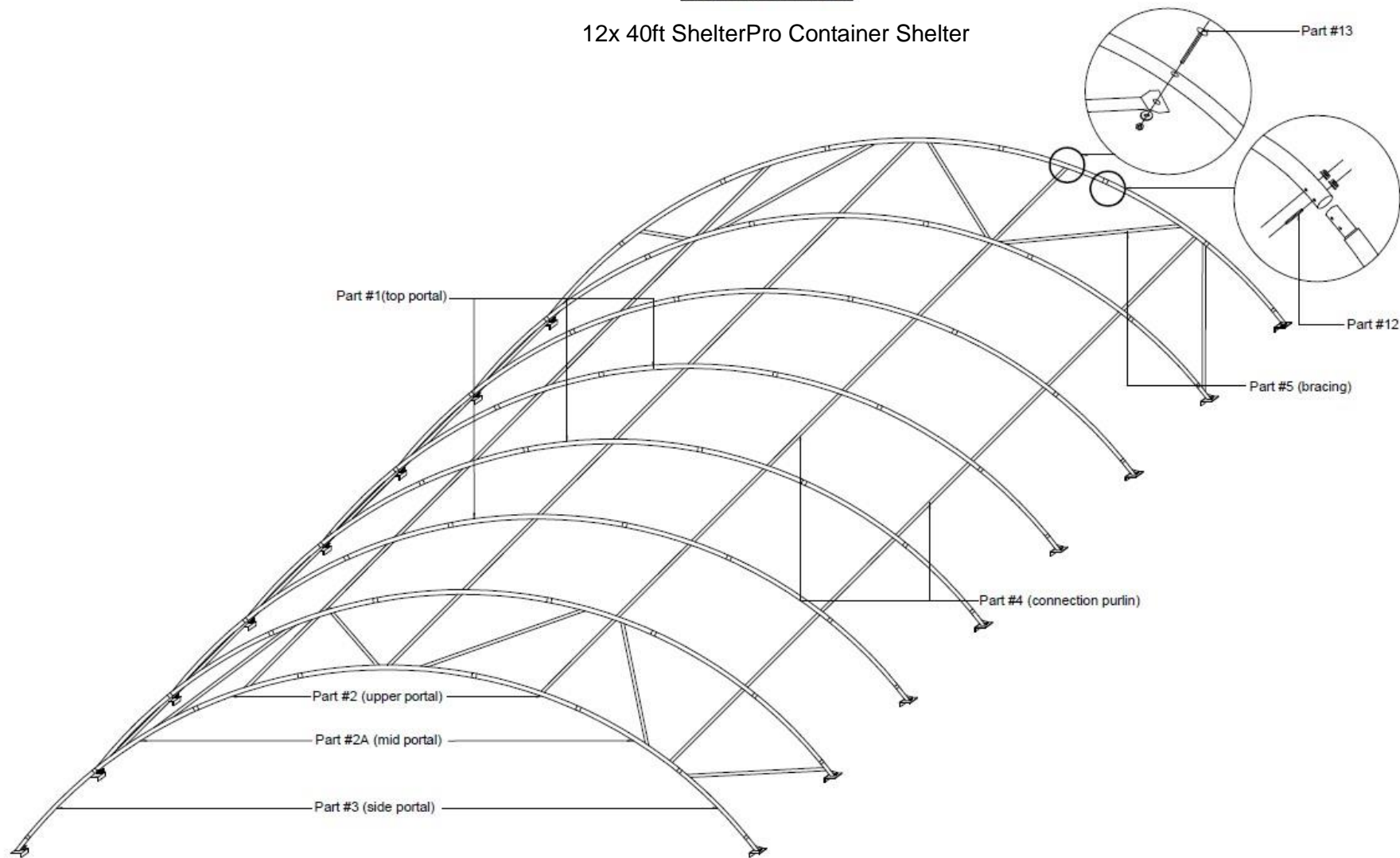

STEP 1 - CONTAINER LAYOUT & POSITIONING

Both containers should be of equal height and on firm, level ground.
Position containers 11.7m apart.

Note: If containers are not fixed to concrete piers for anchorage, they should be ballasted. Suggest a minimum of 500kgs per meter for length of each container.

Standard 20' and 40' container layout diagram.

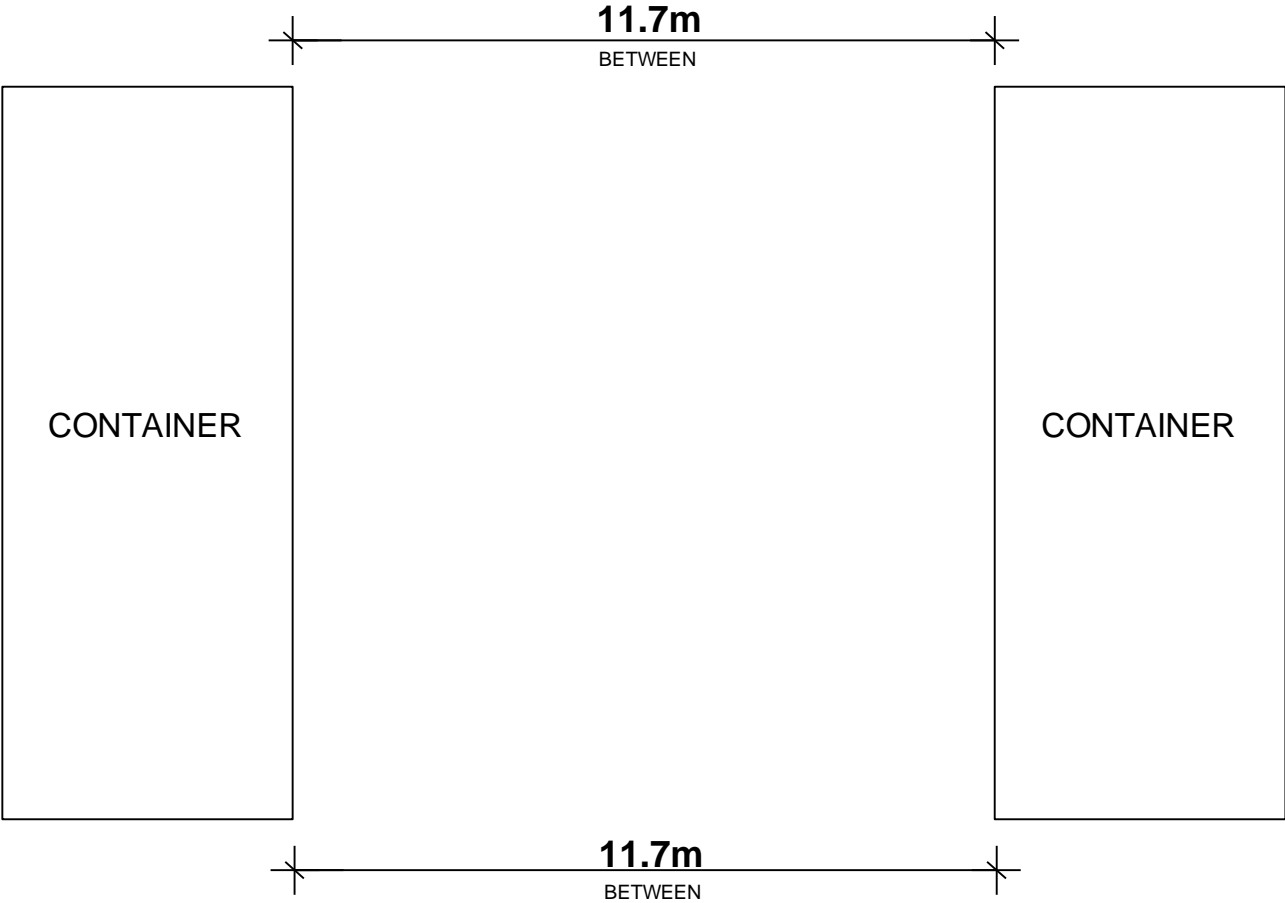

STEP 2 - BASE PLATE LAYOUT 6.0m (20')

The distance from the center spigot to the center spigot for welding the base plates into position can be checked by measuring from center to center of the drilled holes in the connection purlins (part #4)

Note the position of the base plate (parts #R1) on the diagram.

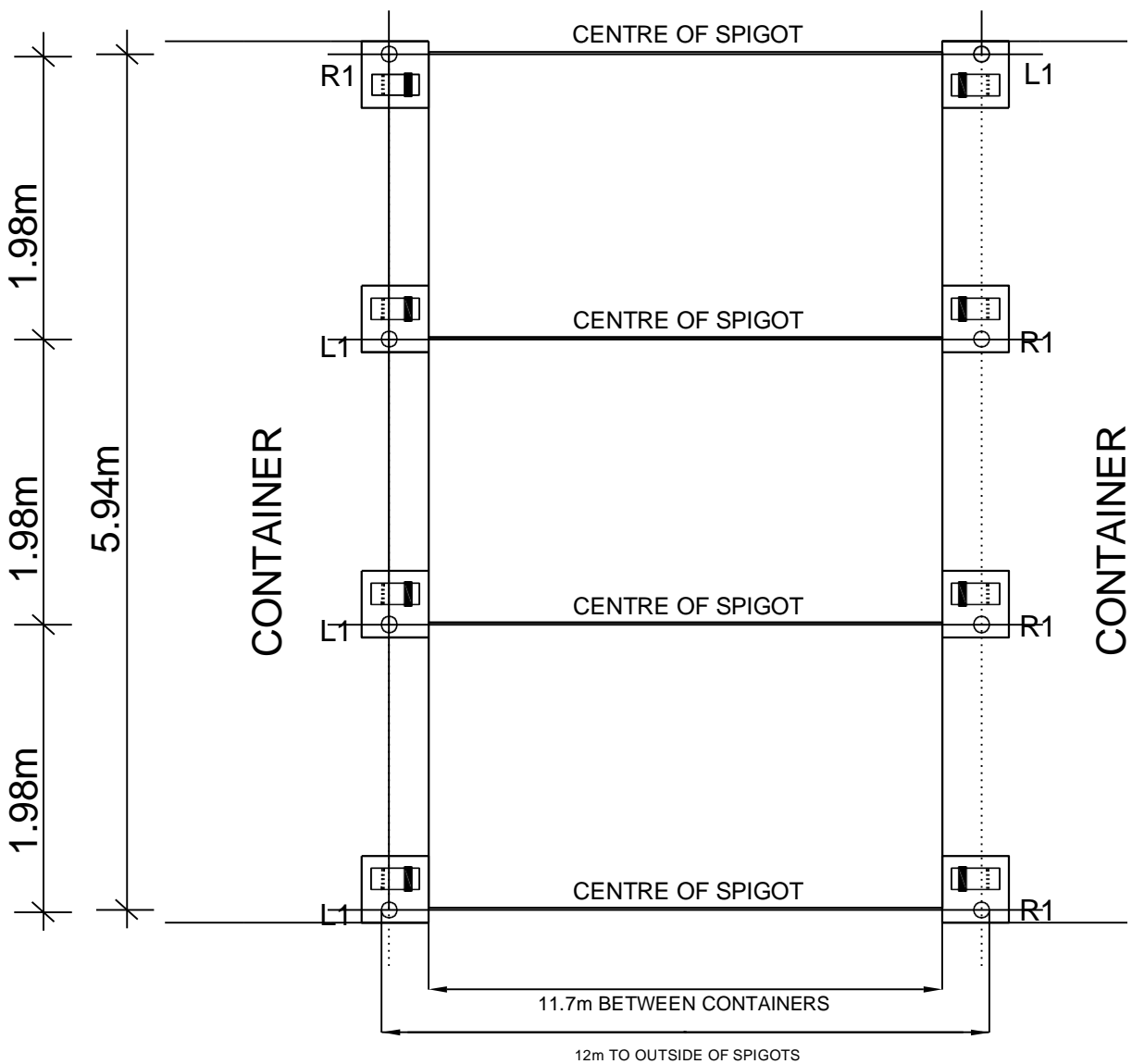

STEP 2 - BASE PLATE LAYOUT 12.0m (40')

Note the position of base plate (parts #R1) on diagram.

The distance from the center spigot to the center spigot for welding the base plates into position can be checked by measuring from center to center of the drilled holes in the connection purlins (part #4)

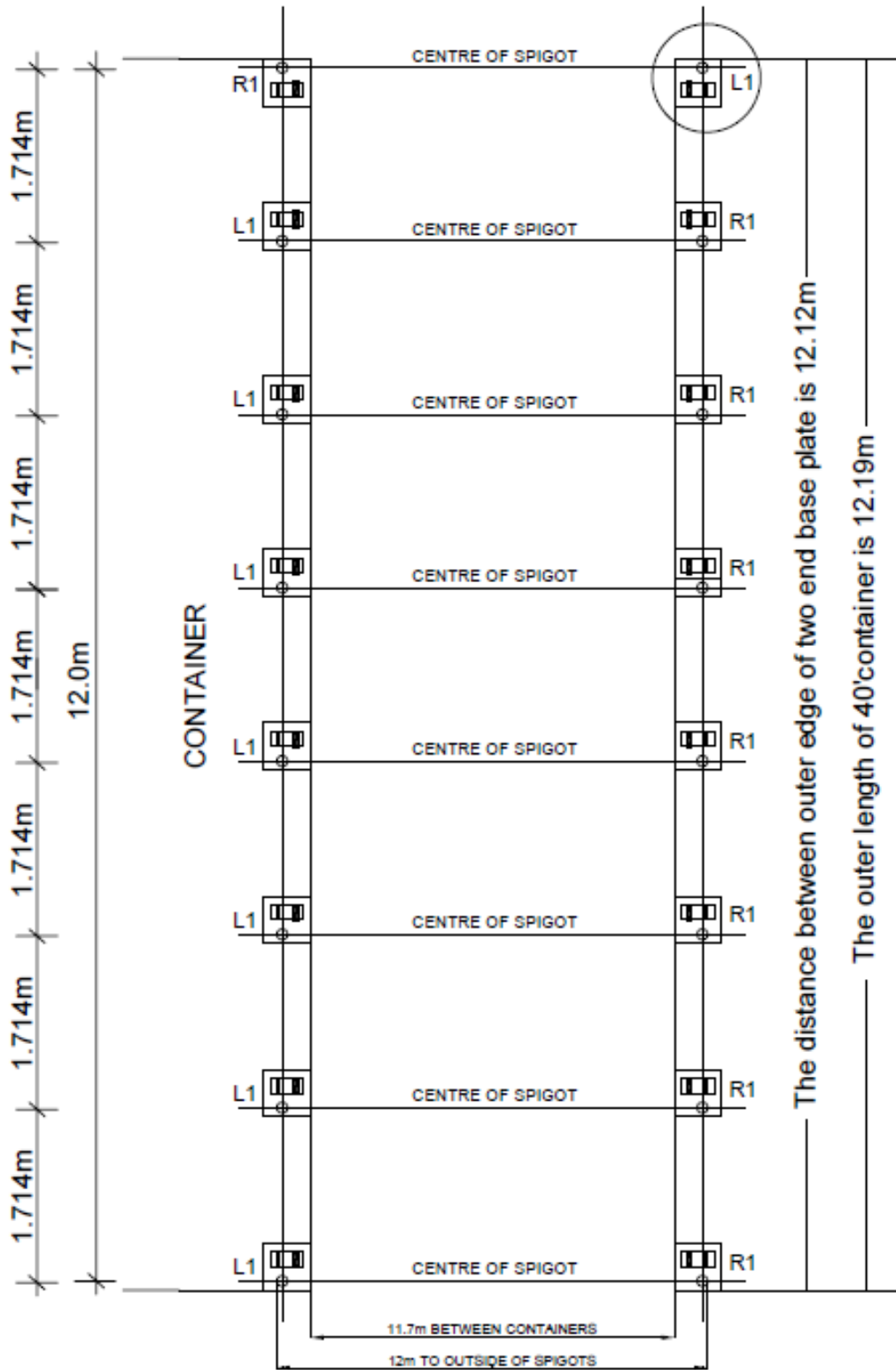

STEP 3 – BASE PLATE FIXING

1. Position the base plates (parts # L1 & R1) to the container tops.
Note the positions of the base plates on the layout diagrams on pages 7 & 8.

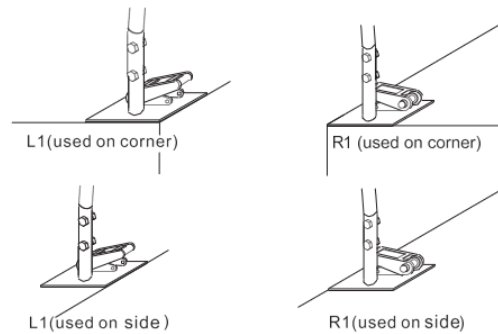

2. Weld the base plate to the container tops securely.
3. Weld the ratchets for all four corners (Part #8) to the front and back corner edges of the containers corner lock blocks, as per below images. (ensure they are mounted with enough height that the container doors can still open)
4. Install ratchets onto the brackets on the base plates using the supplied bolts (part # 15)



STEP 4 - PORTAL ASSEMBLY

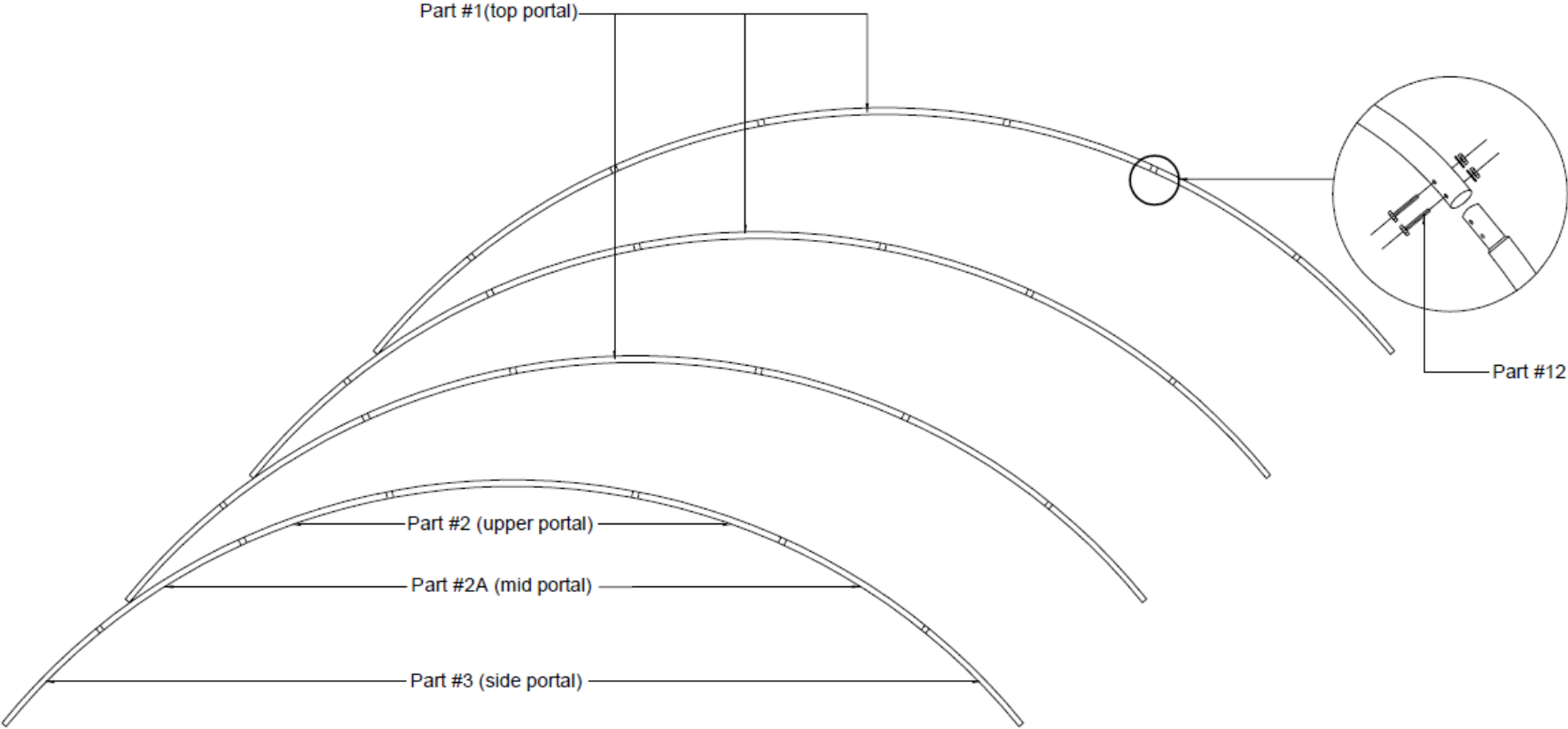

1. Assemble all individual portals (arches) on the ground first.
2. Bolt together using supplied bolts - Part #12.
3. Bracing Brackets - Part # 6 are required for the first and last 2 portals only.
6 pcs for each portal.

STEP 5 - FRAME ASSEMBLY CONT'

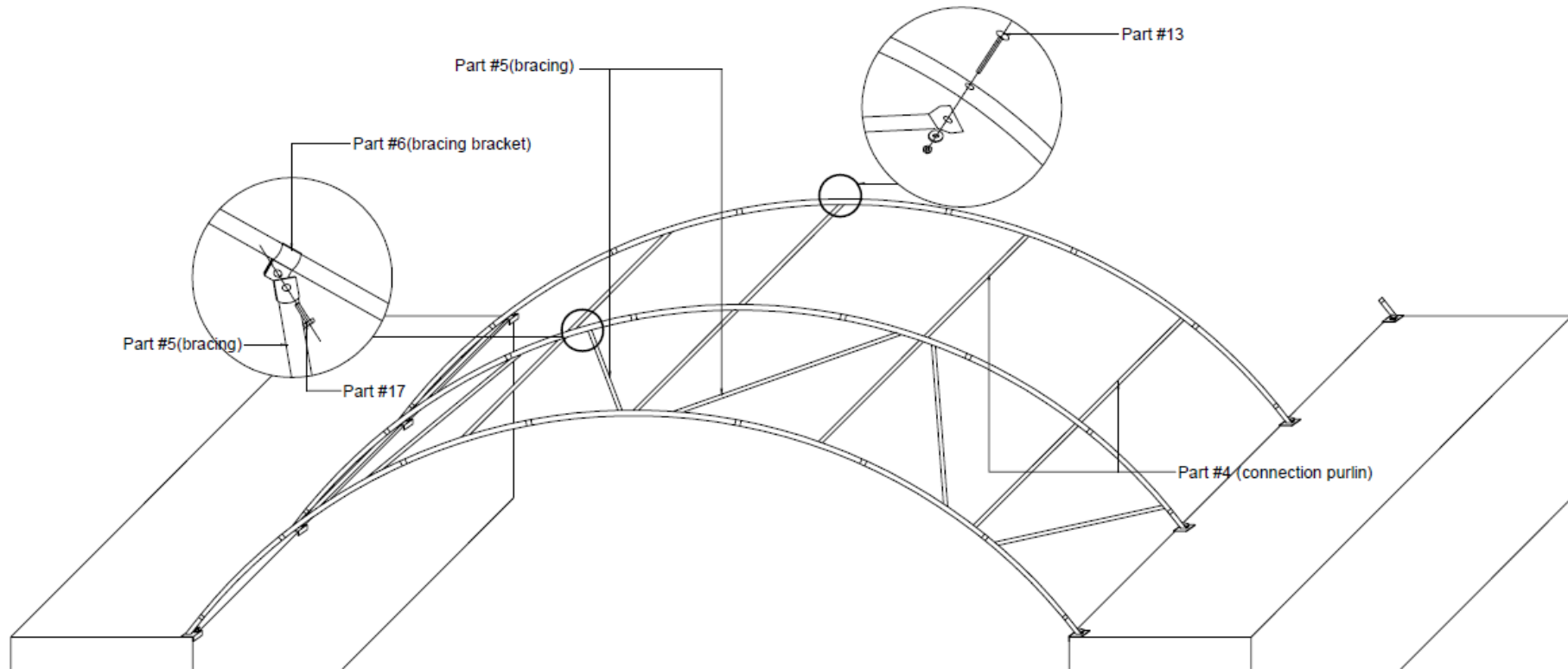

1. Lift the fully assembled end portal (arch) onto the secured corner base plates.
2. Drop the portal onto the spigots of the base plate on one side, gently ease portal in and drop down onto spigot on opposite side (portals go in under tension) and secure using bolts. (Part #12).
3. Repeat this process with all portals (arches).
4. Connect the first two portals with the Purlins (Part #4) & Bolts (Part #13).
5. Connect Bracings (Part #5) to portals by Brackets and Bolts (Part # 17). Bracing is required only between the first two portals, and the last two portals.

STEP 6 - FRAME ASSEMBLY CONT'

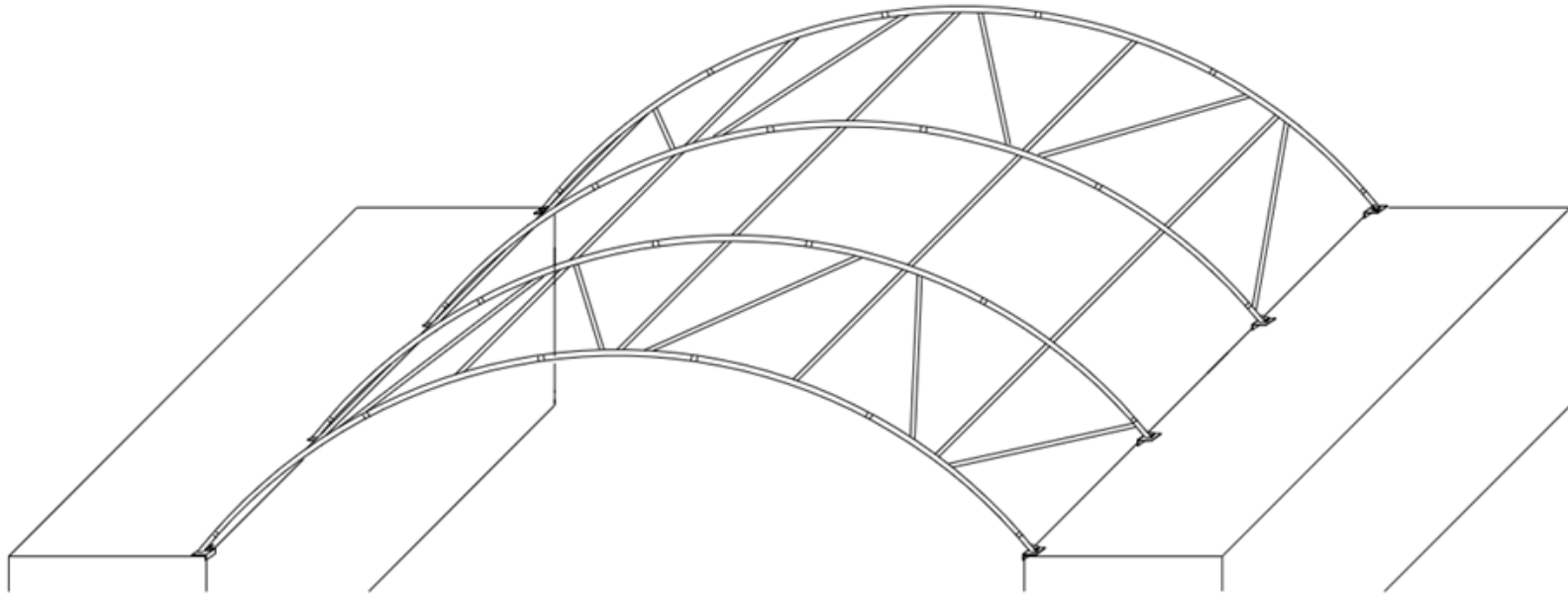

1. Repeat step 5 (1 - 5), until all portals (arches) are in position and bolted to the base plates, all purlins are connected using bolts (Part # 13), and all bracings are connected using brackets (Part #6) & bolts (Part #17).
2. Fix the self-adhesive, anti friction frame tape (Part # 16) to the top side of the swaged joints on the portals. This will help to protect the cover where rubbing occurs on the swaged joints.
3. Bind cable ties around the frame tapes to prevent frame tape lifting and curling when cover is pulled over frame.

STEP 7 PREPARE MAIN COVER

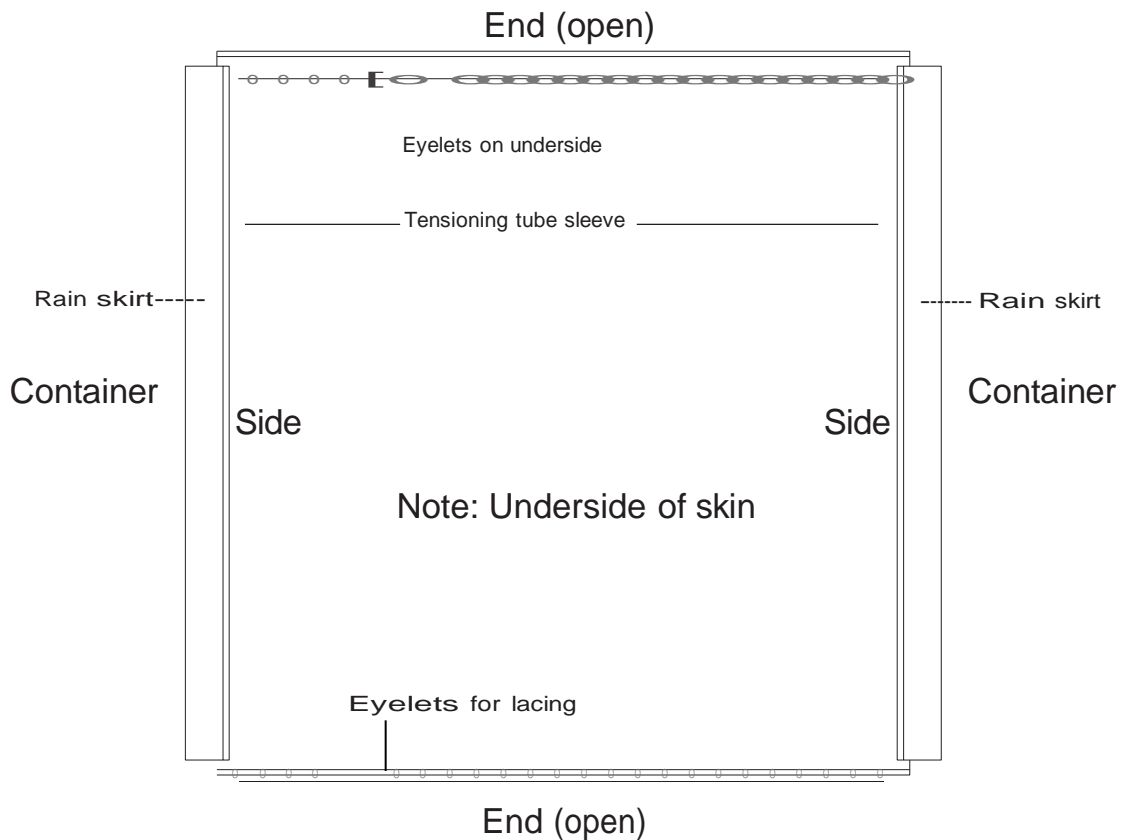

1. Unfold the cover carefully and locate the two end pouches which contain the choke bands, already threaded through. There will also be a row of eyelets on the underside of each end close to the choke bands pouch.
2. The underside of the cover also has a sleeve running along each side which will hold the tensioning tubes.
3. Position the cover on one side of the shelter with the eyelets and sleeve on the underside ready to slide over the frame.
4. Insert tensioning tubes (Part #7) into the sleeve on the lead side, and install end plugs (Part #10) on to 2 ends of tube sets. Tie ropes onto the tensioning tubes through the small slits which were cut on the sleeve. Throw ropes over to the opposite side of the shelter.



STEP 8 - COVER INSTALLATION

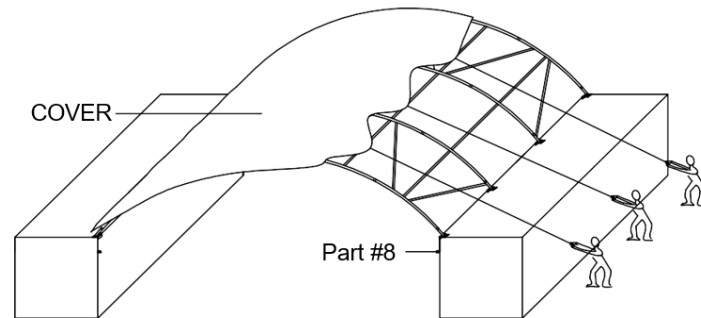

Note: Ensure the cover is the right way around and have an even amount of cover overhanging at both ends of the frame. Sleeves are on the underside and are on the sides of the cover only. The ends of the cover have the choke bands already threaded through as well as the eyelets on the underside.

1. Insert the tensioning tubes (part #7) into the sleeves on both sides of the cover and install the end plugs (part #10) onto the 4 ends of the tube sets. Tie the rope to the tensioning tube at equal points along the side to be pulled over.
2. Position one man per rope, standing on the ground on the other side of the container.
3. Collectively ease the cover over the top of the frame from one side to the other, checking that the cover is not catching on any purlins from the underside. Work steadily & evenly without excessive force.
4. Once the cover is square on the frame, ensure even overhang at both ends and even height on both sides. Immediately secure the four corners using the choke bands to the rachets for four corners.
5. Double-check that the cover continues to be square on the frame.
6. Fix & re-tension the choke bands securely at each end to the ratchet.



STEP 9 - COVER TENSIONING



Installing ratchet straps

1. Starting at the top and center at both ends thread the lacing rope (part #11) through the eyelets on the underside of the cover around the upper-end portal. This is to create longitudinal tensions. Ensure all knots are secure.
2. Further tension the choke ropes again. Do not move onto ratchets until choke bands are completely tensioned. Recheck lacing.
3. Tensioning of the choke bands and tightening of the lacing is the most important part of the cover installation.
4. Using a shape knife cut a corresponding slit in the tensioning tube sleeves directly above the ratchet to match the width of the ratchet straps (Part #14)
5. Starting from the middle ratchet on each side tension the cover progressively by treading the ratchet strap over tensioning tube and down into the ratchet on the base plate. Do not apply full tension to the ratchet at this time.
6. Once the end ratchets have been reached go back and apply more tension to all ratchets starting from the middle. This is necessary as the cover takes a little time to equalize the tension and settle on the frame.
7. Secure the rain flaps to the container with sand bags, or by affixing it permanently with teck screws and penny washers to the container top or rolled up and affixed back to the base plate spigots.
8. Next day go back and repeat steps 2,3 & 4 again. This should be done periodically to constantly maintain tension on the cover.

STEP 10 - COMPLETION - Take a look



1. Step back and observe, is your cover and shelter looking good?
2. Are all choke ropes tight and tied off securely?
3. No folds, bagging, or loose cover?
4. Even overhang at both front and back, tensioned tightly?
5. Ratchets evenly tensioned?
6. Lacing ropes tied securely and pulled tight?
7. Completion - congratulations!

Back Wall for 12m Wide Container Shelter

PARTS LIST

PART #	DESCRIPTION	QUANTITY
18	Back cover	1
19	Lacing ropes for back cover	6
20	Side poles	2
21	Mid poles	3
22	Upper mid pole	1
23	Upper side poles	2
24	Rails	4
25	Tensioning tubes	3+1
26	Side Base Plate	2
27	Mid base plates	3
28	Stake pegs	10
29	Pole brackets	4
30	Hexagon bolts for swaged ends	34
31	Hexagon bolts for connecting rails	16
32	Bolts for pole bracket	8
33	End plugs tensioning tube	2
34	Small flange with "D" rings	10
35	Ball bungeed cords	10
36	Clamps for swagged ends on poles	3

Assembly

1. Bolt all Poles (Part #20, 21, 22, 23) and Base Plates (Part #26, 27) together on ground by bolts (Part #30). Install Clamps for swaged ends on poles (Part #36) by bolts (Part #32), this is to reinforce swaged ends.
2. Bolt Rails (Part #24) to poles by Bolts (Part #31).
3. Get Pole Brackets (Part #29) through end portal. Stand the assembled ball wall structure, and bolt it to the end portal by brackets and Bolt (Part #32).
4. Fix base plates to ground by Stake Pegs (Part #28) immediately.
5. Insert End Pluges (Part #33) to Tensioning Tubes (Part #25), then insert tensioning tubes into the clips on base plates. Back wall structure is assembled well now.
6. Install Back Cover (Part #18) to back wall structure now. There are 3 bands on top of back cover which assist installation. Making the 3 bands going around end portal, tie end cover to proper position. It will be much easier to lace end cover later.
7. Now, lace back cover by Lacing Ropes (Part #19).
8. Recheck it again to make sure steel structure is fixed well and cover is laced fully.
9. There are side flaps at two sides of back cover, weld the small flanges with "D" Ring (Part #34) on containers closed to the eyelets on side flaps (or fix the small flanges with "D" ring to containers by self-tapping screws, both are OK). Then tie side flaps to "D" rings using Ball Bungeed Cords (Part #35).

NOTE: If there is location/installation tolerance during assembly of the back wall, please adjust base plates or container distance slightly.

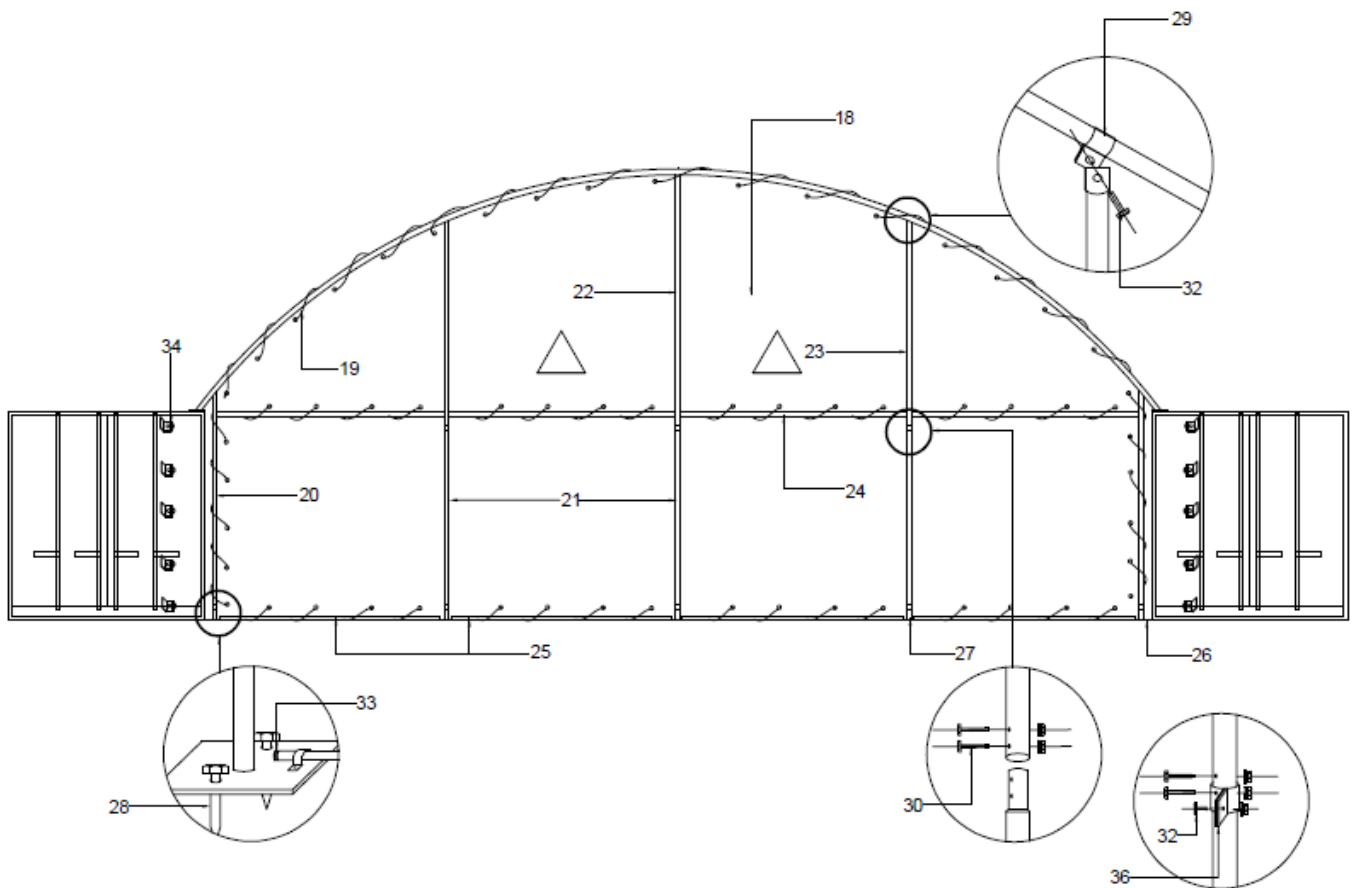



FINAL ADVICE & IMPORTANCE OF ONGOING MAINTENANCE

- ✓ Be sure to secure all the base plates firmly to the surface and make sure they are spaced correctly (refer to the manual for set out). Failure to do so may result in an unstable structure or the cover being able to move and wear on the frame.
- ✓ Make sure that you installed the cover correctly – please refer to the cover assembly instructions in your assembly manual. You should have tensioned the ends (choke ropes before you tensioned the sides (ratchets).
- ✓ Always ensure cover tension is maintained.
- ✓ Check all the choke ropes are kept tight and tied off at all times.
- ✓ Ensure all lacing is kept tensioned and tied off at all times.
- ✓ Ensure all ratchet straps are in place and kept tight at all times.
- ✓ If the cover is allowed to flap or move, it will wear and damage itself. You can lengthen the life of the shelter if you take this very simple precaution.
- ✓ If the cover is loose, fix the problem immediately to avoid water pooling or the wind pulling and straining the structure. Keep checking this occasionally the entire time your shelter is assembled.
- ✓ Periodically go back and check that your base plates or base rails remain firmly secure to the surface you have assembled them on.
- ✓ Should you damage or break something on your shelter, please fix it immediately.
- ✓ In the event of severe weather or cyclonic weather conditions being forecast, ShelterPro advises and recommends removal of the cover from your shelter prior to weather hitting. This will avoid damage to the cover and shelter caused by other flying debris or severe wind.
- ✓ If you require any further product information, assembly support, or replacement parts – please feel free to contact our team of friendly staff.